

KlassikDrain - KS100 Stainless steel edge rail channel system

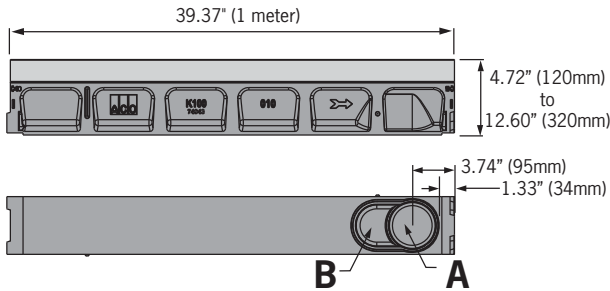

One meter channel



Half meter channel

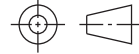
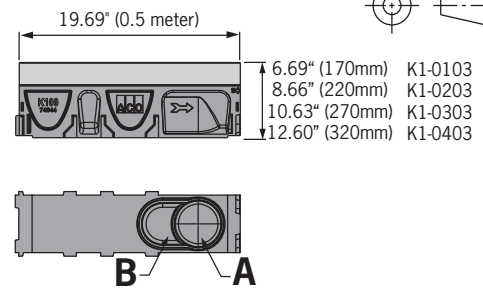

Knock-outs included on every 5th channel

Type K901S In-line catch basin

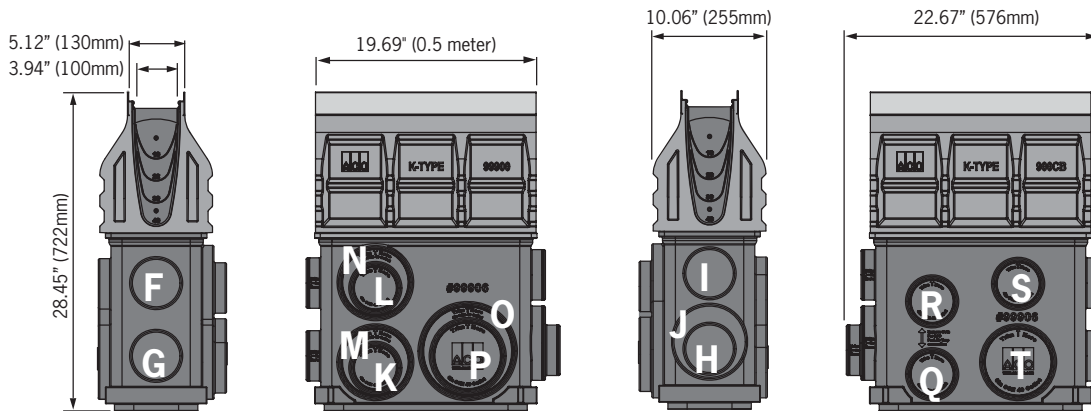

Total capacity = 10.49 gallons.

Outlet flow rates

Outlet	Product	Outlet size (Sch. 40)	Invert Depth	GPM	CFS
A	Bottom outlet - KS00	4" round	3.94"	108	0.24
A	Bottom outlet - KS40	4" round	11.81"	187	0.42
B	Bottom outlet - KS00	6" oval	3.94"	177	0.39
B	Bottom outlet - KS40	6" oval	11.81"	306	0.68
C	End outlet - KS20	4" round	7.87"	132	0.29
C	End outlet - KS40	4" round	11.81"	171	0.38
D	KS1-308-6 6" outlet cap	6" oval	9.84"	233	0.52
E	KS1-408-6 6" outlet cap	6" oval	11.81"	264	0.59
F	Type KS1-901S	4" round	19.30"	226	0.50
G	Type KS1-901S	4" round	25.67"	265	0.59
H	Type KS1-901S	4" round	25.30"	263	0.59
I	Type KS1-901S	4" round	18.56"	222	0.49
J	Type KS1-901S	6" round	25.85"	586	1.30
K	Type KS1-901S	4" round	26.43"	269	0.60
L	Type KS1-901S	4" round	19.36"	227	0.51
M	Type KS1-901S	6" round	27.30"	604	1.35
N	Type KS1-901S	6" round	19.99"	505	1.12
O	Type KS1-901S	8" round	27.30"	1051	2.34
P	Type KS1-901S	6" round	26.43"	593	1.32
Q	Type KS1-901S	4" round	27.17"	273	0.61
R	Type KS1-901S	4" round	20.68"	235	0.52
S	Type KS1-901S	4" round	18.99"	224	0.50
T	Type KS1-901S	6" round	27.17"	602	1.34

Note: These are the pipe flow rates at the specified outlet, NOT channel flow rates. Catch basin flow rates are without trash bucket - using trash bucket reduces flow.

End Caps

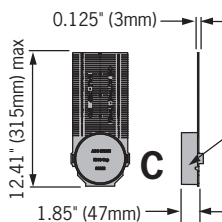

6" Oval inlet cap

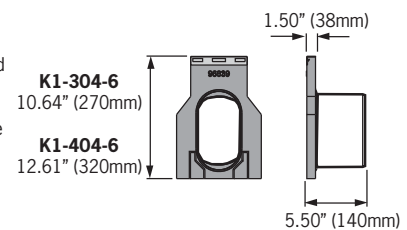

6" Oval outlet cap

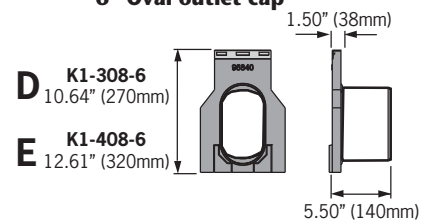

ACO DRAIN

KlassikDrain - KS100 Stainless steel edge rail channel system



ACO Specification Information

Description	Part No.	Invert Inches ²	mm ²	Weight Lbs.
KS1-00 Neutral channel - 39.37" (1m)^D	74441	3.94	100	28.1
KS1-1 Sloped channel - 39.37" (1m)	74401	4.13	105	28.1
KS1-2 Sloped channel - 39.37" (1m)	74402	4.33	110	28.9
KS1-3 Sloped channel - 39.37" (1m)	74403	4.53	115	29.7
KS1-4 Sloped channel - 39.37" (1m)	74404	4.72	120	30.5
KS1-5 Sloped channel - 39.37" (1m) ^D	74405	4.92	125	31.3
KS1-6 Sloped channel - 39.37" (1m)	74406	5.12	130	32.1
KS1-7 Sloped channel - 39.37" (1m)	74407	5.31	135	32.9
KS1-8 Sloped channel - 39.37" (1m)	74408	5.51	140	33.7
KS1-9 Sloped channel - 39.37" (1m)	74409	5.71	145	34.5
KS1-10 Sloped channel - 39.37" (1m) ^D	74410	5.91	150	35.3
KS1-010 Neutral channel - 39.37" (1m)^D	74443	5.91	150	35.3
KS1-0103 Neutral channel - 19.69" (0.5m)^D	74444	5.91	150	17.0
KS1-11 Sloped channel - 39.37" (1m)	74411	6.10	155	36.1
KS1-12 Sloped channel - 39.37" (1m)	74412	6.30	160	36.9
KS1-13 Sloped channel - 39.37" (1m)	74413	6.50	165	37.7
KS1-14 Sloped channel - 39.37" (1m)	74414	6.69	170	38.5
KS1-15 Sloped channel - 39.37" (1m) ^D	74415	6.89	175	39.3
KS1-16 Sloped channel - 39.37" (1m)	74416	7.09	180	40.1
KS1-17 Sloped channel - 39.37" (1m)	74417	7.28	185	40.9
KS1-18 Sloped channel - 39.37" (1m)	74418	7.48	190	41.7
KS1-19 Sloped channel - 39.37" (1m)	74419	7.68	195	42.5
KS1-20 Sloped channel - 39.37" (1m) ^D	74420	7.87	200	43.4
KS1-020 Neutral channel - 39.37" (1m)^D	74445	7.87	200	43.4
KS1-0203 Neutral channel - 19.69" (0.5m)^D	74446	7.87	200	20.5
KS1-21 Sloped channel - 39.37" (1m)	74421	8.07	205	44.2
KS1-22 Sloped channel - 39.37" (1m)	74422	8.27	210	45.0
KS1-23 Sloped channel - 39.37" (1m)	74423	8.46	215	45.8
KS1-24 Sloped channel - 39.37" (1m)	74424	8.66	220	46.6
KS1-25 Sloped channel - 39.37" (1m) ^D	74425	8.86	225	47.4
KS1-26 Sloped channel - 39.37" (1m)	74426	9.06	230	48.2
KS1-27 Sloped channel - 39.37" (1m)	74427	9.25	235	49.0

Description	Part No.	Invert Inches ²	mm ²	Weight Lbs.
KS1-28 Sloped channel - 39.37" (1m)	74428	9.45	240	49.8
KS1-29 Sloped channel - 39.37" (1m)	74429	9.65	245	50.6
KS1-30 Sloped channel - 39.37" (1m) ^D	74430	9.84	250	51.4
KS1-030 Neutral channel - 39.37" (1m)^D	74447	9.84	250	51.4
KS1-0303 Neutral channel - 19.69" (0.5m)^D	74448	9.84	250	24.0
KS1-31 Sloped channel - 39.37" (1m)	74431	10.04	255	52.2
KS1-32 Sloped channel - 39.37" (1m)	74432	10.24	260	53.0
KS1-33 Sloped channel - 39.37" (1m)	74433	10.43	265	53.8
KS1-34 Sloped channel - 39.37" (1m)	74434	10.63	270	54.6
KS1-35 Sloped channel - 39.37" (1m) ^D	74435	10.83	275	55.4
KS1-36 Sloped channel - 39.37" (1m)	74436	11.02	280	56.2
KS1-37 Sloped channel - 39.37" (1m)	74437	11.22	285	57.0
KS1-38 Sloped channel - 39.37" (1m)	74438	11.42	290	57.9
KS1-39 Sloped channel - 39.37" (1m)	74439	11.61	295	58.7
KS1-40 Sloped channel - 39.37" (1m) ^D	74440	11.81	300	59.5
KS1-040 Neutral channel - 39.37" (1m)^D	74449	11.81	300	59.5
KS1-0403 Neutral channel - 19.69" (0.5m)^D	74450	11.81	300	27.5
KS1-901S In-line catch basin - 19.69" (0.5m) ^D	94609	27.63	702	52.6
KS1-621S catch basin - 19.69" (0.5m) ^D	94618	28.86	733	55.8
KS1-631S catch basin - 19.69" (0.5m) ^D	94632	40.86	1038	65.8
Series 600 Optional plastic riser	99902	-	-	10.0
Foul air trap - fits both 900 & 600 series basins	90854	-	-	1.2
KS1-304-6 6" Inlet Cap	96844	9.84	250	5.2
KS1-308-6 6" Outlet Cap	96845	9.84	250	5.0
KS1-404-6 6" Inlet Cap	96846	11.81	300	6.0
KS1-408-6 6" Outlet Cap	96847	11.81	300	5.8
Universal end cap	96822	11.81	300	0.4
Debris strainer for 4" bottom knockout	93488	-	-	0.2
4" Oval to 6" round outlet adapter	95140	-	-	1.1
K1-Installation device	97477	-	-	2.8
Grate removal tool	01318	-	-	0.3
K1-QuickLok locking bar	02899	-	-	0.1

Notes:

1. This channel offers a bottom knockout feature; 4" round/6" oval.
2. Inverts shown are for the male end; for female invert depth subtract 5mm (≈0.2") from the male invert (except for neutral channels, where it will be same as male invert). To calculate the overall channel depth add 20mm (≈0.8") to invert depth.
3. This catch basin kit includes a polymer concrete top, removable Quicklok locking bar, trash bucket and plastic base. Select an appropriate grate.
4. This catch basin kit includes a polymer concrete top, removable Quicklok locking bar, deep trash bucket, plastic riser and plastic base. Select an appropriate grate.

Specifications		Water absorption	0.07%	cast in by the manufacturer to ensure maximum
General		Frost proof	YES	homogeneity between polymer concrete body and
The surface drainage system shall be ACO Drain KS100 complete with gratings secured with 'QuickLok' locking as manufactured by ACO Polymer Products, Inc. or approved equal.		Salt proof	YES	edge rail. Each edge rail shall be at least 3/32" (2.5mm) thick.
Materials		Dilute acid and alkali resistant	YES	
The trench system bodies shall be manufactured from polyester polymer concrete with the minimum properties as follows:		The nominal clear opening shall be 4" (100mm) with overall width of 5.12" (130mm). Pre-cast units shall be manufactured with either an invert slope of 0.5% or with neutral invert and have a wall thickness of at least 0.50" (13mm). Each unit will feature a partial radius in the trench bottom and a male to female interconnecting end profile. Units shall have horizontal cast in anchoring keys on the outside wall to ensure maximum mechanical bond to the surrounding bedding material and pavement surface. The stainless steel edge rail will be integrally		Grates
Compressive strength:	14,000 psi			Grates shall be specified. See separate ACO Spec Info grate sheets for details. After removal of gratings and 'QuickLok' bar there shall be uninterrupted access to the trench to aid maintenance.
Flexural strength:	4,000 psi			Installation
				The trench drain system shall be installed in accordance with the manufacturer's installation instructions and recommendations.

ACO Polymer Products, Inc.

Northeast Sales Office
P.O. Box 245
Chardon, OH 44024
Tel: (440) 285-7000
Toll free: (800) 543-4764
Fax: (440) 285-7005

West Sales Office
P.O. Box 12067
Casa Grande, AZ 85130
Tel: (520) 421-9988
Toll Free: (888) 490-9552
Fax: (520) 421-9899

Southeast Sales Office
4211 Pleasant Road
Fort Mill, SC 29708
Toll free: (800) 543-4764
Fax: (803) 802-1063



Electronic Contact:
info@ACODrain.us
www.ACODrain.us



© September 25, 2013 ACO Polymer Products, Inc. This information is believed to be accurate but it is not guaranteed to be so. We cannot assume liability for results that buyer obtains with our product since conditions of use are beyond the control of the company. It is the customer's responsibility to evaluate suitability and safety of product for his own use. ACO Polymer Products Inc. reserves the right to change the product and specifications without notice.